

TOP VIEW

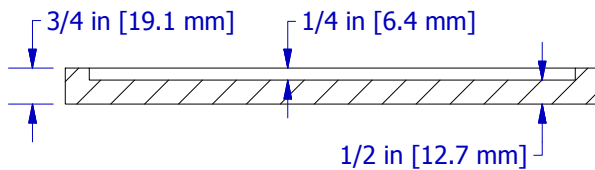

SECTION VIEW

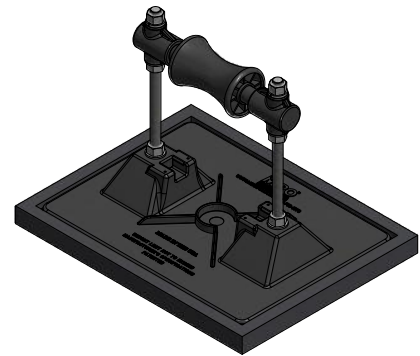

SUPPORT PAD UNDER A MIRO 3-RAH-7 (NOT INCLUDED)

PRODUCT DESCRIPTION

Custom support pad designed specifically to fit the MIRO 7-1/2"x10" [190.5x254 mm] polycarbonate non-penetrating base. The slip resistant pads are designed with a small lip to hold the base to the pad and reduce movement on the rooftop. The holes in the pad saves weight and allows for venting and drainage. The pads are heat molded using 100% recycled rubber.

KEY INFORMATION

- Custom fitted support pad for the MIRO 7-1/2"x10" [190.5x254 mm] polycarbonate base.
- To be use with MIRO Models:
 - 3-RAH-7
 - 2.5-Conduit Support-2, 5 & 7
 - 24-Base Strut-5 (qty: 2)
 - 36-Base Strut-5 (qty: 3)
 - 48-Base Strut-5 (qty: 4)

This document, attachments, and all of the information therein are the property of MIRO Industries, Inc. The information contained is loaned, subject to return upon demand, and is not to be used directly or indirectly in any way detrimental to our interest. Further the information contained therein shall not be used, in whole or in part, except when allowed by written authorization from MIRO Industries, Inc. © MIRO INDUSTRIES, INC. 2003-2014

7-1/2"x10" Rubber Support Pad

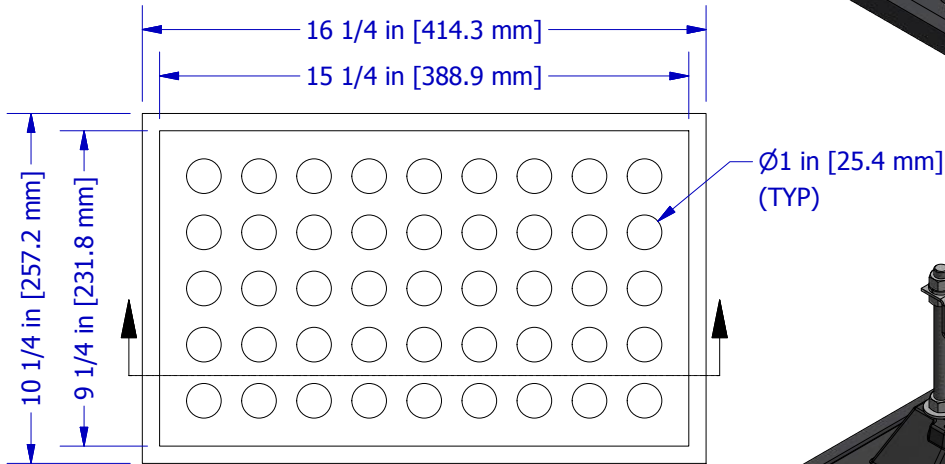

TOP VIEW

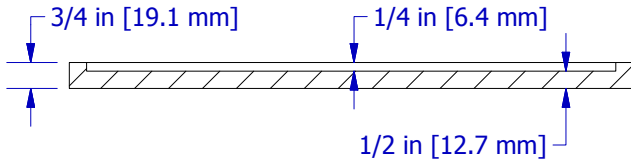

SECTION VIEW

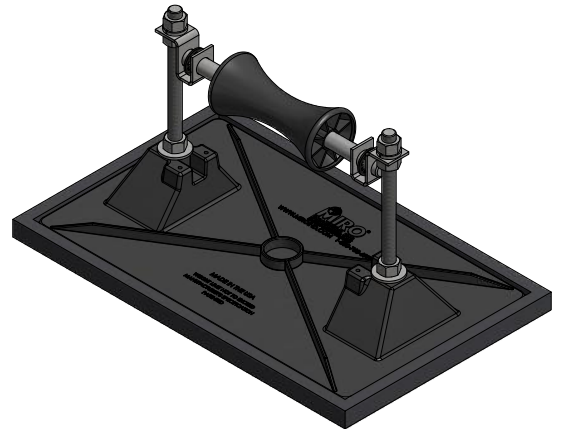

SUPPORT PAD UNDER A MIRO 5-RAH-7 (NOT INCLUDED)

PRODUCT DESCRIPTION

Custom support pad designed specifically to fit the MIRO 9"x15-1/4" [228.6x387.35 mm] polycarbonate non-penetrating base. The slip resistant pads are designed with a small lip to hold the base to the pad and reduce movement on the rooftop. The holes in the pad saves weight and allows for venting and drainage. The pads are heat molded using 100% recycled rubber.

KEY INFORMATION

- Custom fitted support pad for the MIRO 9"x15-1/4" [228.6x387.35 mm] polycarbonate base.
- To be use with MIRO Models:
 - 3-RAH-12
 - 4-RAH-7 & 12
 - 5-R, 5-RAH-7 & 12
 - 2.5-Conduit Support-12
 - 16-Base Strut-7, & 12
 - 2.5-SB-H
 - 6-H Series (qty: 2 min)
 - 6-DS Series (qty: 2 min)

This document, attachments, and all of the information therein are the property of MIRO Industries, Inc. The information contained is loaned, subject to return upon demand, and is not to be used directly or indirectly in any way detrimental to our interest. Further the information contained therein shall not be used, in whole or in part, except when allowed by written authorization from MIRO Industries, Inc. © MIRO INDUSTRIES, INC. 2003-2014

9"x15-1/4" Rubber Support Pad

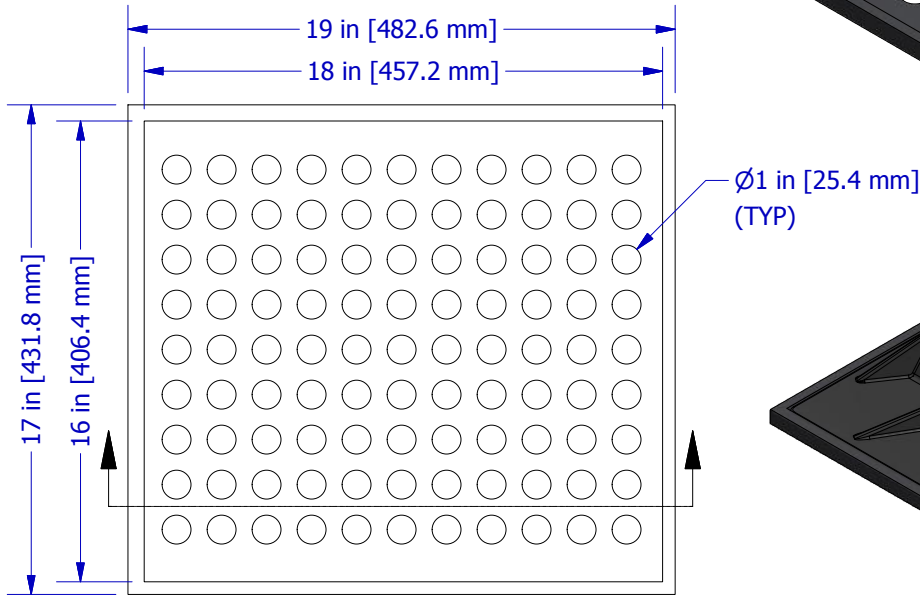
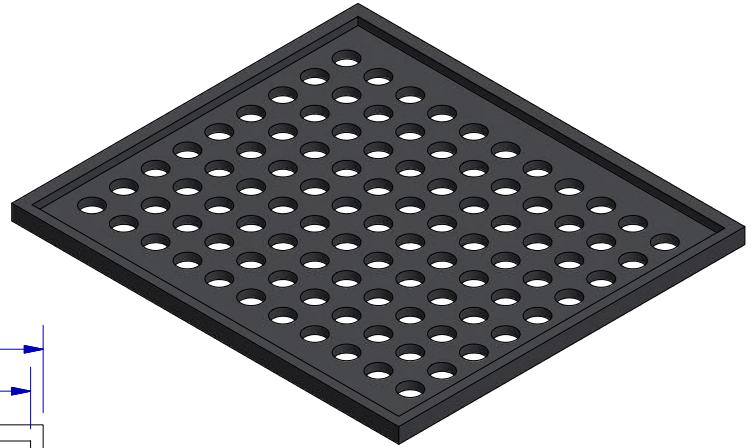

TOP VIEW

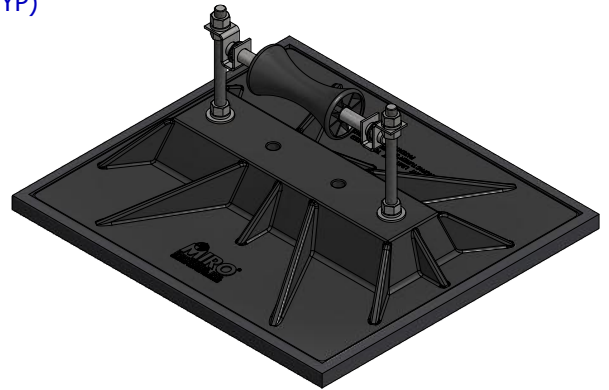

SUPPORT PAD UNDER A MIRO 6-RAH-7 (NOT INCLUDED)

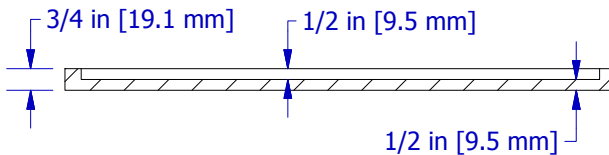

SECTION VIEW

PRODUCT DESCRIPTION

Custom support pad designed specifically to fit the MIRO 16"x18" [406.4x457.2 mm] polycarbonate non-penetrating base. The slip resistant pads are designed with a small lip to hold the base to the pad and reduce movement on the rooftop. The holes in the pad saves weight and allows for venting and drainage. The pads are heat molded using 100% recycled rubber.

KEY INFORMATION

- Custom fitted support pad for the MIRO 16"x18" [406.4x457.2 mm] polycarbonate base.
- To be use with MIRO Models:
 - 6-RAH-7 & 12
 - 20-Base Strut-7 & 12
 - 5-SB-H
 - 8-H Series (qty: 2 min)
 - 16-H Series (qty: 4 min)
 - 8-DS Series (qty: 2 min)
 - HD Mechanical Supports (qty: 4 min)
 - Bridge Crossovers, Walkway, Service Platforms & Ramps (qty: varies)

This document, attachments, and all of the information therein are the property of MIRO Industries, Inc. The information contained is loaned, subject to return upon demand, and is not to be used directly or indirectly in any way detrimental to our interest. Further the information contained therein shall not be used, in whole or in part, except when allowed by written authorization from MIRO Industries, Inc. © MIRO INDUSTRIES, INC. 2003-2014

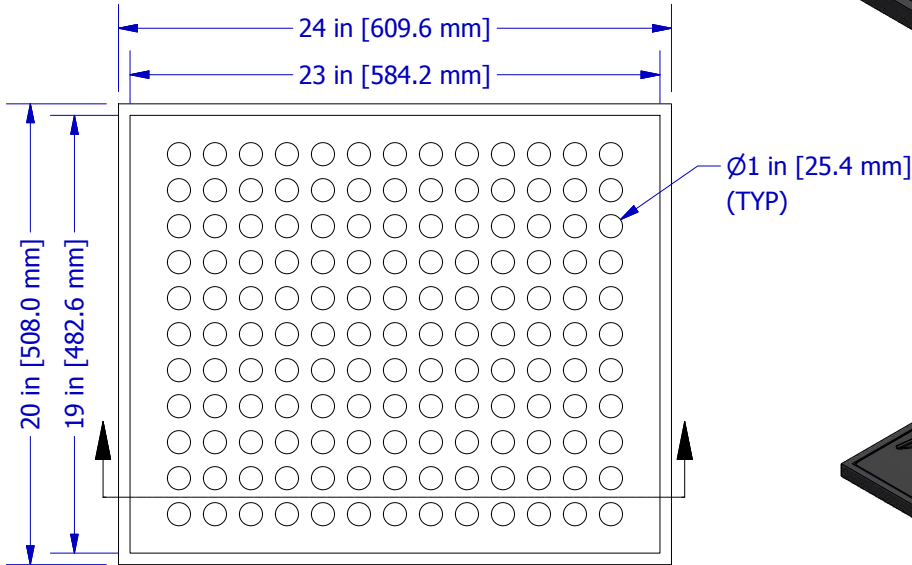

TOP VIEW

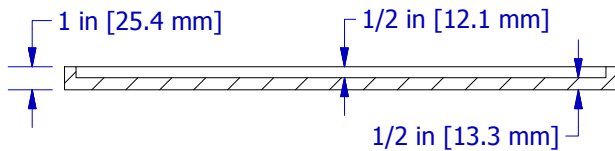

SECTION VIEW



SUPPORT PAD UNDER A MIRO 24-BASE STRUT-18 (NOT INCLUDED)

PRODUCT DESCRIPTION

Custom support pad designed specifically to fit the MIRO 19"x23" [482.6x584.2 mm] polycarbonate non-penetrating base. The slip resistant pads are designed with a small lip to hold the base to the pad and reduce movement on the rooftop. The holes in the pad saves weight and allows for venting and drainage. The pads are heat molded using 100% recycled rubber.

KEY INFORMATION

- Custom fitted support pad for the MIRO 19"x23" [482.6x584.2 mm] polycarbonate base.
- To be use with MIRO Models:
 - 8-RAH-18
 - 24-Base Strut-4 & 18
 - 10-H Series (qty: 2 min)
 - 10-DS Series (qty: 2 min)
 - HD Mechanical Supports (qty: 4 min)
 - Bridge Crossovers, Walkway, Service Platforms & Ramps (qty: varies)

This document, attachments, and all of the information therein are the property of MIRO Industries, Inc. The information contained is loaned, subject to return upon demand, and is not to be used directly or indirectly in any way detrimental to our interest. Further the information contained therein shall not be used, in whole or in part, except when allowed by written authorization from MIRO Industries, Inc. © MIRO INDUSTRIES, INC. 2003-2014

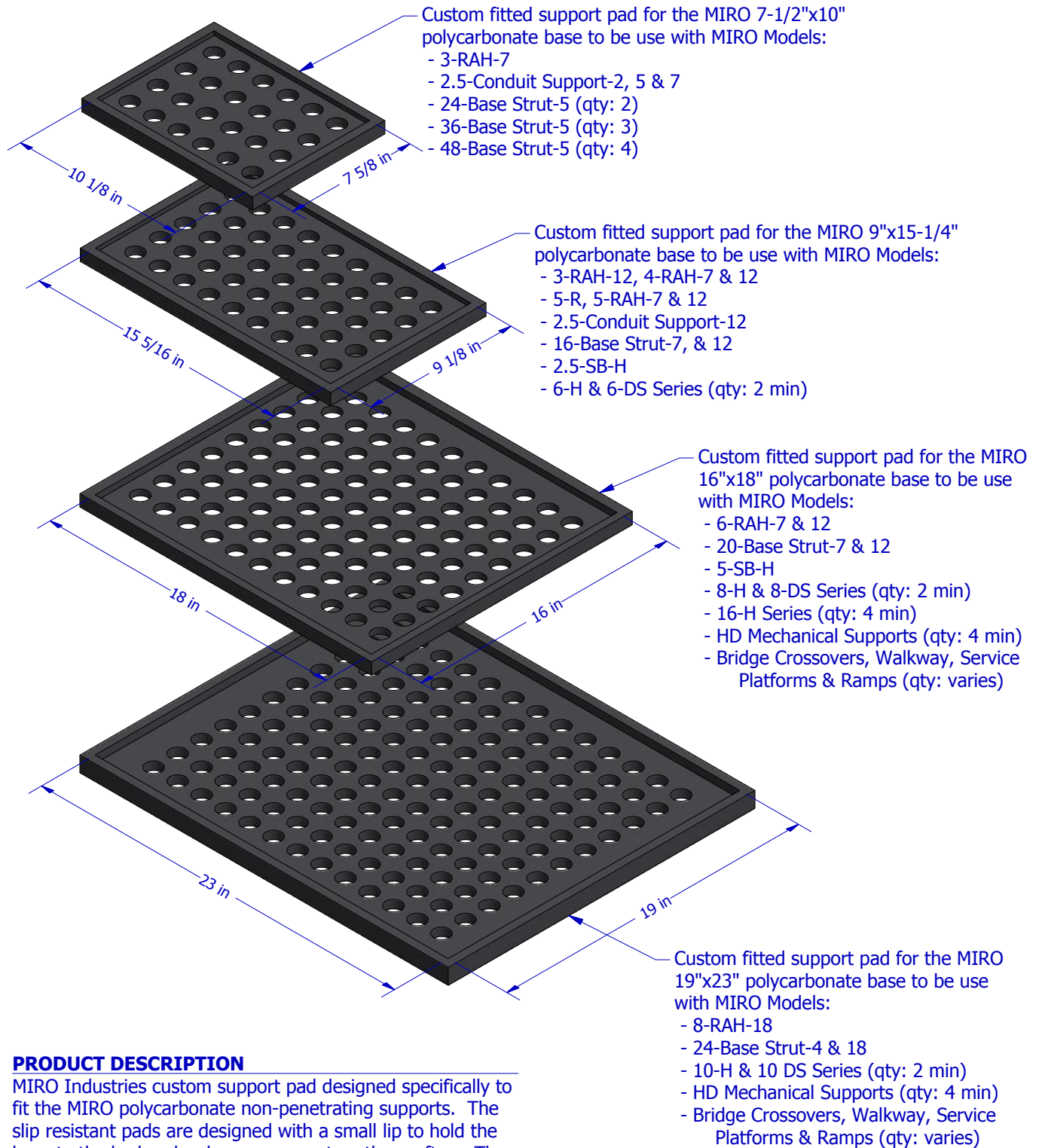

PRODUCT DESCRIPTION

MIRO Industries custom support pad designed specifically to fit the MIRO polycarbonate non-penetrating supports. The slip resistant pads are designed with a small lip to hold the base to the pad and reduce movement on the rooftop. The holes in the pad saves weight and allows for venting and drainage. The pads are heat molded using 100% recycled rubber.



PRODUCT DESCRIPTION

MIRO Industries custom support pad designed specifically to fit the MIRO polycarbonate non-penetrating supports. The slip resistant pads are designed with a small lip to hold the base to the pad and reduce movement on the rooftop. The holes in the pad saves weight and allows for venting and drainage. The pads are heat molded using 100% recycled rubber.

This document, attachments, and all of the information therein are the property of MIRO Industries, Inc. The information contained is loaned, subject to return upon demand, and is not to be used directly or indirectly in any way detrimental to our interest. Further the information contained therein shall not be used, in whole or in part, except when allowed by written authorization from MIRO Industries, Inc. © MIRO INDUSTRIES, INC. 2003-2014